

Double Orifice Air Valve with Integrated Isolation Valve



Pressure Rating: PN 16
 Material of Construction: Ductile Cast Iron GGG 40/50
 Stainless Steel Balls

DN 50 - DN 200

Catalogue No: 8-2230016-SA

Range of application: Potable water				
Size DN	Pressure rating PN	Hydrotest pressure in bar		Admissible working pressure in bar up to 70°C
		Body	Seat	
50 - 200	16	24	16	16

In case of order please specify the working conditions



Materials / Equipment	
Catalogue No.	8-2230016-SA
Body	EN-GJS 500-7 (GGG 50)
Covers	EN-GJS 500-7 (GGG 50)
Balls	Stainless steel 304
Gaskets	EPDM or NBR
Stem	Stainless steel 420
Valve seat on the cone	EPDM or NBR
Bolts and nuts	Stainless steel 304
Corrosion protection	Epoxy powder coated RAL 5015
Handwheel	EN-GJS 500-7

size DN mm	Dimensions				Weight kg	Volume m³
	D mm	L mm	B mm	H mm		
50	165	420	170	325	31	0.02
80	200	420	250	360	43	0.06
100	220	500	280	412	60	0.09
150	285	650	400	530	265	0.21
200	340	650	500	530	296	0.38

We reserve the right to make technical modifications

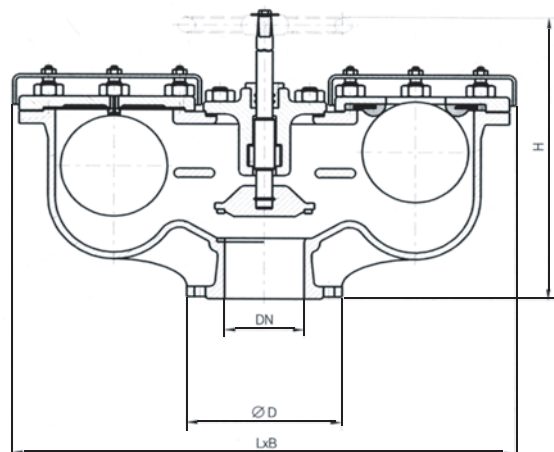

SAUDI VALVES MANUFACTURING

Tel.: +966 3 341 8514 - Fax: +966 3 341 8515
 P. O. Box 10137 Jubail Industrial City, 31961 The Kingdom of Saudi Arabia
 E-mail: info@saudivalves.com - Internet: www.saudivalves.com

ISO 9001

BUREAU VERITAS
 Certification



N° 215125

20.03.2009